



GENERAL CATALOGUE 2014 2015



CERTIFIED
Product Quality
License Nos.:
Q1412 and Q1428

bticino

CONTENT



**GENERAL
CATALOGUE 2014/2015**

BAMBOO 2

DUTON 4

MULTI OUTLET EXTENSION CORD 4

MAGIC ADVANCE 5

MATIX 8

IDROBOX 17

POP - UP 18

PASS AND SEYMOUR 19

INDUSTRIAL SOCKETS 20

LIGHTING MANAGEMENT AND SWITCH SENSOR..... 22

D45 HIGH PERFORMANCE DOOR ENTRY SYSTEM..... 24

BAMBOO

BAMBOO APPLIED TO THE ASIAN LIFESTYLE
AND WIDELY USED IN ASIAN CONTINENT,

REFLECTS STRENGTH, QUALITY AND BEAUTY.



Italian design, Bamboo can fit every requirement of a quality product for public, office and residence as well as competitive cost dwelling.

More modern with wide rocker, the switch has pure and brilliant white. The symbol engraved on the key switch that gives more aesthetic.

PRIORITY MATTER, BAMBOO HAS HIGH QUALITY AND SAFETY ASSURED:

- The switch has the **double silver nickel contact** that carries high electrical current up to 16AX and excellent conductor.
- Made of **fine brass**, part of the switch mechanism does not rust.
- Maximum safety in simplex and duplex sockets with separated **safety shutter system**.
- The spiral terminals with **plate lock system** allow easy wires installation and well locked. For safety reason, it is also covered with plastic insulation.
- Life time **operations > 100,000 times**

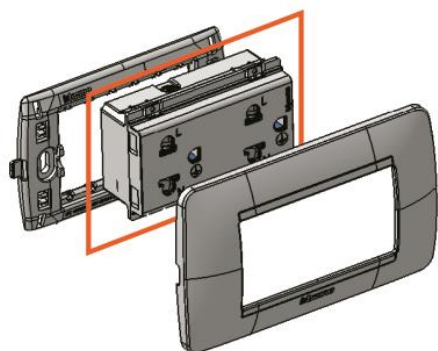
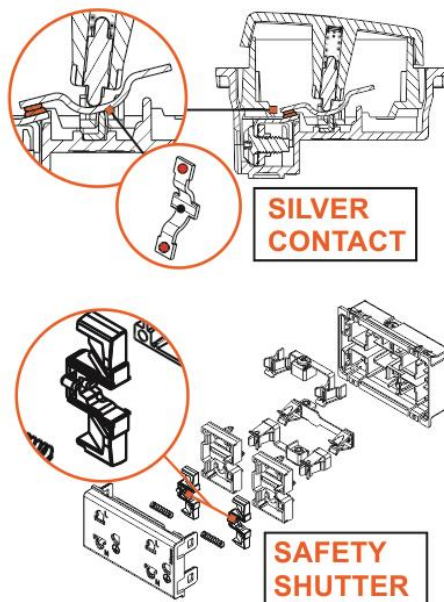

BECAUSE OF THE 'FRONTAL'
FITTING; THE SOCKET HAS
NO RISK TO BE PUSHED INSIDE.



BAMBOO DEVICES

COMPLETE SET (DIY)

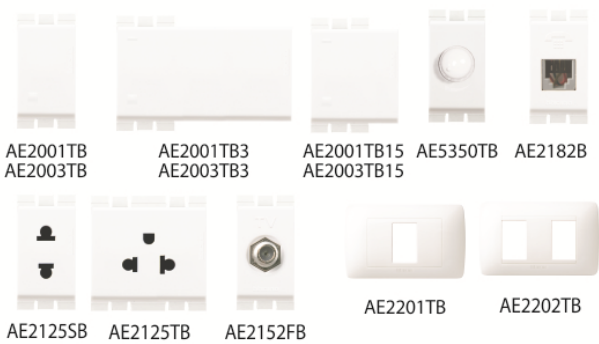

Item		SWITCHES AND DIMMER	Price
AE2001TB		1P 16A one way switch	42.00
AE2003TB		1P 16A two way switch	80.00
AE2001TB15		1P 16A one way switch 1.5 modules	70.00
AE2001TB3		1P 16A one way switch 3 modules	70.00
AE2003TB15		1P 16A two way switch 1.5 modules	93.00
AE2003TB3		1P 16A two way switch 3 modules	108.00
AE2005B		1P 10A push button switch	108.00
AE5350TB		Dimmer 300W	773.00
AE2000B		blank insert	21.00

Item		ACCESSORY	Price
AM5503S		wall-mounted box 2'x6' (115x71x40mm)	29.00

Item		SOCKETS EURO-US	Price
AE2125SB		16A 250V a.c. 2P EURO - US socket	42.00
AE2125TB		16A 250V a.c. 2P+G EURO - US simplex socket with ground and safety shutter, 2 modules	64.75
AE2125DB		16A 250V a.c. 2P EURO - US duplex universal socket with ground and with safety shutter, 3 modules	178.00

Item		DO-IT-YOURSELF (COMPLETE SET)	Price
SAE2001TBA		1G 1 Way single pole switch 16A 250V	74.75
SAE2001TB15A		2G 1 Way switch 1.5 module 16A-250V	142.75
SAE2001TB3A		1G 1 Way switch 3 module 16A-250V	87.75
SAE2003TBA		1G 2 Way single pole switch 16A 250V	112.75
SAE2201TBA		2G 1 Way single pole switch 16A 250V	116.75
SAE2301TBA		3G 1 Way single pole switch 16A 250V	158.75
SAE2003TB15A		2G two way switch 16A 250V 1.5 modules	248.75
SAE2003TB3A		1G two way switch 16A 250V 3 modules	140.75
SAE2125DBA		Duplex universal outlet 2P+E 16A 250V	210.75
SAE2125TBA		Universal/ simplex outlet 2P+E 16A 250V	97.50
SAE2125SBA		One gang Euro-US outlet 2P 16A 250V	74.75
SAE2225SBA		Two gang Euro-US outlet 2P 16A 250V	116.75
SAE2152FBA		One gang television outlet- F type	162.50
SAE2182BA		One gang telephone outlet- 2 pairs RJ11	132.50
SAE2179C5BA		One gang RJ45 UTP category 5e - UTP	372.75
SAE2179C6BA		One gang RJ45 UTP category 6 - UTP	393.75
SAE5350TBA		One gang rotary dimmer	805.75

Item		TELEPHONE, DATA AND TV SOCKET OUTLET	Price
AE2182B		telephone connector RJ11	99.75
AE2152DB		shunted TV socket female 9.5 mm.	240.00
AE2152FB		TV socket (F type)	129.75
AE2179C5B		RJ45 connector cat.5E -UTP- tooless	340.00
AE2179C6B		RJ45 connector cat.6 -UTP- tooless	361.00

Item		COVER PLATE	Price
AE2201TB PH		1 module cover plate with fine screw	25.75
AE2202TB PH		2 modules cover plate with fine screw	25.75
AE2203TB PH		3 modules cover plate with fine screw	25.75
AE2222TB PH		2 modules centered cover plate with fine screw	25.75
AE2200TB PH		blank cover plate with fine screw	25.75
AE2206TB PH		3+3 modules cover plate with fine screw	130.00

DUTON DOOR BELL SYSTEM

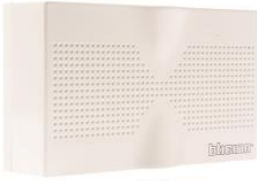

S74N



89E

MULTI-SOCKET EXTENSION CORD



3 sockets



5 sockets



6 sockets

Item	DUTON DOOR BELL		Price
S74N		Duton surface mounted door bell with two harmonious notes 50 / 60 Hz 230V	520.00
89E		Duton weatherproof push button mounted horizontal or vertical on standard utility boxes IP44	340.00

Item	MULTI-SOCKET EXTENSION CORD	Price
S3650P	Extension Cord 3outlet - 3 gang	475.00
S3651P	Extension Cord 5outlet - 5 gang	560.00
S3652P	Extension Cord 6outlet - 6 gang	600.00

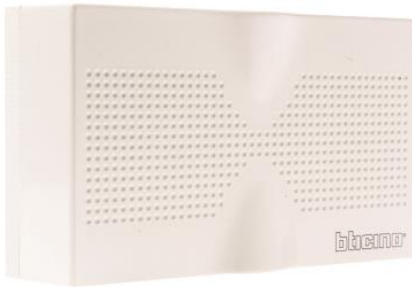

SAFETY DEVICE



Item	BREAKER, FUSE AND INSTALLATION DEVICE		Price
BREAKER MAGITIK®			
M9210		Miniature C.B. 10A 3kA - 1 module	2,100.00
M9216		Miniature C.B. 16A 3kA - 1 module	2,850.00
M9256S		Earth Leakage Circuit Breaker 16A 220V A.C. 10mA 2kA 2 module	3,500.00
M9089		Fuse holder 4A-16A	613.00
T/4 Fuse 4A, T/6 Fuse 6A, T/10 Fuse 10A, T/16 Fuse 16A			105.00

Item	SIGNAL LIGHT AND LAMP 3W 230V		Price
M9060R		Red color - with lamp 11220B	879.00
M9060V		Green color - with lamp 11220B	1,059.00
M9060B		White color - with lamp 11220B	881.00
M9060A		Orange color - with lamp 11220B	881.00
M9741/230*		Lamp	216.00
LN4742V230**		Location discharge bulb 230V - coupling with studs -orange	105.00
LN4742V230T**		Location discharge bulb 230V - coupling with studs -green	137.00

*Do not use with fluorescent

** Refer to page 16 for the illustration on the installation of LED backlighting connection on a switch

COVER PLATE



Item	PLASTIC COVER PLATE		Price
WHITE COLOR COVER PLATE			
M903/11P		1 module White Cover Plate	38.00
M903/12P		2 module White Cover Plate	38.00
M903/13P		3 module White Cover Plate	38.00
M903/23P		Square White Cover Plate	38.00
M903/30P		Rectangle White Cover Plate	38.00
M998P		blank cover plate	38.00
M906/14P		4 module White Cover Plate	70.00
M906/16P		6 module White Cover Plate	70.00
SILVER COLOR COVER PLATE			
M903/11PSA		1 module Silver Cover Plate	80.00
M903/12PSA		2 module Silver Cover Plate	80.00
M903/13PSA		3 module Silver Cover Plate	80.00
M903/23PSA		Square Silver Cover Plate	80.00
M903/30PSA		Rectangle Silver Cover Plate	80.00
M906/14PSA		4 module Silver Cover Plate	232.00
M906/16PSA		6 module Silver Cover Plate	232.00
GOLD COLOR COVER PLATE			
M903/11POR		1 module Gold Cover Plate	80.00
M903/12POR		2 module Gold Cover Plate	80.00
M903/13POR		3 module Gold Cover Plate	80.00
M903/23POR		Square Gold Cover Plate	80.00
M903/30POR		Rectangle Gold Cover Plate	80.00
M906/14POR		4 module Gold Cover Plate	263.00
M906/16POR		6 module Gold Cover Plate	263.00

SAFETY DEVICE



Item	BREAKER, FUSE AND INSTALLATION DEVICE		Price
BREAKER MAGITIK®			
M9210		Miniature C.B. 10A 3kA - 1 module	2,100.00
M9216		Miniature C.B. 16A 3kA - 1 module	2,850.00
M9256S		Earth Leakage Circuit Breaker 16A 220V A.C. 10mA 2kA 2 module	3,500.00
M9089		Fuse holder 4A-16A	613.00
T/4 Fuse 4A, T/6 Fuse 6A, T/10 Fuse 10A, T/16 Fuse 16A			105.00

Item	SIGNAL LIGHT AND LAMP 3W 230V		Price
M9060R		Red color - with lamp 11220B	879.00
M9060V		Green color - with lamp 11220B	1,059.00
M9060B		White color - with lamp 11220B	881.00
M9060A		Orange color - with lamp 11220B	881.00
M9741/230*		Lamp	216.00
LN4742V230		Location discharge bulb 230V - coupling with studs -orange	105.00
LN4742V230T		Location discharge bulb 230V - coupling with studs -green	137.00

*Do not use with fluorescent

COVER PLATE



Item	PLASTIC COVER PLATE		Price
WHITE COLOR COVER PLATE			
M903/11P		1 module White Cover Plate	38.00
M903/12P		2 module White Cover Plate	38.00
M903/13P		3 module White Cover Plate	38.00
M903/23P		Square White Cover Plate	38.00
M903/30P		Rectangle White Cover Plate	38.00
M998P		blank cover plate	38.00
M906/14P		4 module White Cover Plate	70.00
M906/16P		6 module White Cover Plate	70.00
SILVER COLOR COVER PLATE			
M903/11PSA		1 module Silver Cover Plate	80.00
M903/12PSA		2 module Silver Cover Plate	80.00
M903/13PSA		3 module Silver Cover Plate	80.00
M903/23PSA		Square Silver Cover Plate	80.00
M903/30PSA		Rectangle Silver Cover Plate	80.00
M906/14PSA		4 module Silver Cover Plate	232.00
M906/16PSA		6 module Silver Cover Plate	232.00
GOLD COLOR COVER PLATE			
M903/11POR		1 module Gold Cover Plate	80.00
M903/12POR		2 module Gold Cover Plate	80.00
M903/13POR		3 module Gold Cover Plate	80.00
M903/23POR		Square Gold Cover Plate	80.00
M903/30POR		Rectangle Gold Cover Plate	80.00
M906/14POR		4 module Gold Cover Plate	263.00
M906/16POR		6 module Gold Cover Plate	263.00

COVER PLATE



Item	METAL COVER PLATES		Price
SILVER COLOR COVER PLATE			
M903/1S		1 module Aluminum Cover Plate	150.00
M903/2S		2 module Aluminum Cover Plate	150.00
M903/3S		3 module Aluminum Cover Plate	150.00
M903/23S		Square Aluminum Cover Plate	160.00
M903/30S		Rectangle Aluminum Cover Plate	160.00
M998S		Blank cover plate	150.00
M906/4S		4 module Aluminum Cover Plate	350.00
M906/6S		6 module Aluminum Cover Plate	350.00

COMPLETE SET (DIY)

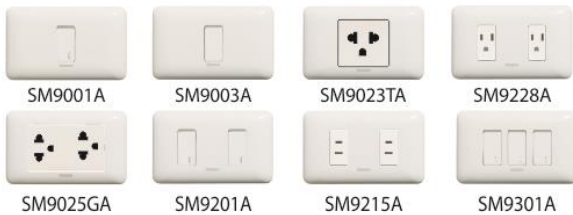

Item	DO-IT-YOURSELF (COMPLETE SET)		Price
SM9001A		One gang one way single pole switch 16A 250V	95.00
SM9003A		One gang two way single pole switch 16A 250V	157.00
SM9023TA		Single universal outlet with ground 2P+E 16A 250V / Aircon outlet	198.00
SM9025GA		Duplex universal outlet 2P+E 10/16A 250V	255.00
SM9201A		Two gang one way single pole switch 16A 250V	145.00
SM9215A		Two gang US outlet (parallel type) without ground 2P 15A 250V	149.00
SM9228A		Two gang US outlet (parallel type) with ground 2P+E 15A 250V	249.00
SM9301A		Three gang one way single pole switch 16A 250V	195.00

ACCESSORY

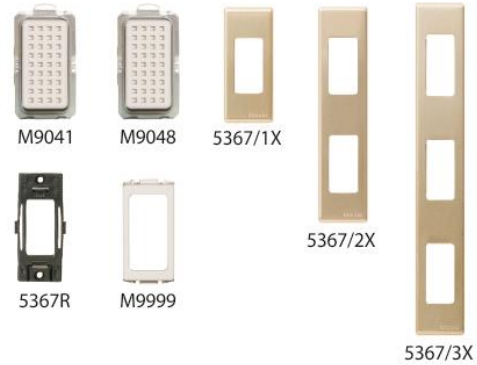

Item	ACCESSORY		Price
SILVER COLOR COVER PLATE			
M9041		Bell 230V 8VA	1,073.00
M9048		Buzzer 230V 8VA	1,093.00
5367/1X		1 module size 30x71 mm	167.00
5367/2X		2 module size 30x129 mm.	308.00
5367/3X		3 module size 30x187 mm.	448.00
5367R		Supporting frames	64.00
M9999		Module adaptor with 1 module	33.00

BOX



Item	BOX AND SUPPORT		Price
WALL-MOUNTED BOX			
AM5503S		Surface Mounting box for AM55... , Size 115x70x40 mm.	29.00
AM5526S		Surface Mounting box for AM5526, Size 115x122x41 mm.	80.00
FLUSH-MOUNTED BOX			
503E		Yellow - flush mounted box for AM5... , Size 108x74x53.5 mm.	36.00
506E		Yellow - flush mounted box for AM5526, Size 108x118x51.5 mm.	121.00
502E		Yellow - for idrobox 2 module, Size 75x71x53 mm.	75.00
FLUSH-MOUNTED FOR PLASTERBOARD BOX			
PB503		Yellow - Box for plasterboard, Size 124x99x40 mm.	151.00
SURFACE AND FLUSH MOUNTED BOX			
M903PS		Surface Mounting box for M903/... Size 115x71x40 mm.	77.00
M906PS		Surface Mounting box for M906/... Size 115x116x40 mm.	102.00

MÀTIX

Universal Solution

RESIDENTIAL SECTOR



INSTALLABILITY



Installation in wall or plasterboard boxes, horizontally, vertically and in the centre



Europa plastic box

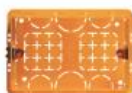

503E



Matix : Modularity Design

FUNCTIONS



AM5256S
Ground Fault
Circuit Interrupter



AM5216S
Thermal magnetic
Circuit Breaker



AM5471
Surge Arrester



AM5706
Rotary
Dimmer



AM5704
Touch
Dimmer



HOTEL FUNCTIONS



AM5765



AM5460



AM5039



AM5062B



AM5064V



A530/230



AM5752



AM4269USBT

SERVICE SECTOR

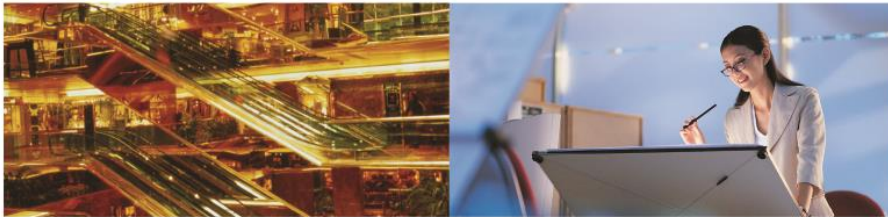

INTERLINK distribution board



Pop-up floor outlet



Desk Mounting



Floor boxes



IP55 covers



switch sensor

waterproof



Contacts made of silver alloy



Safety Shutter

Contacts made of silver alloy

FUNCTIONS FOR THE HOME & SERVICE SECTOR

COMPLETE RANGE OF PRODUCTS FOR THE DWELLING

- traditional control devices
- electronic devices
- sockets suitable for all standards

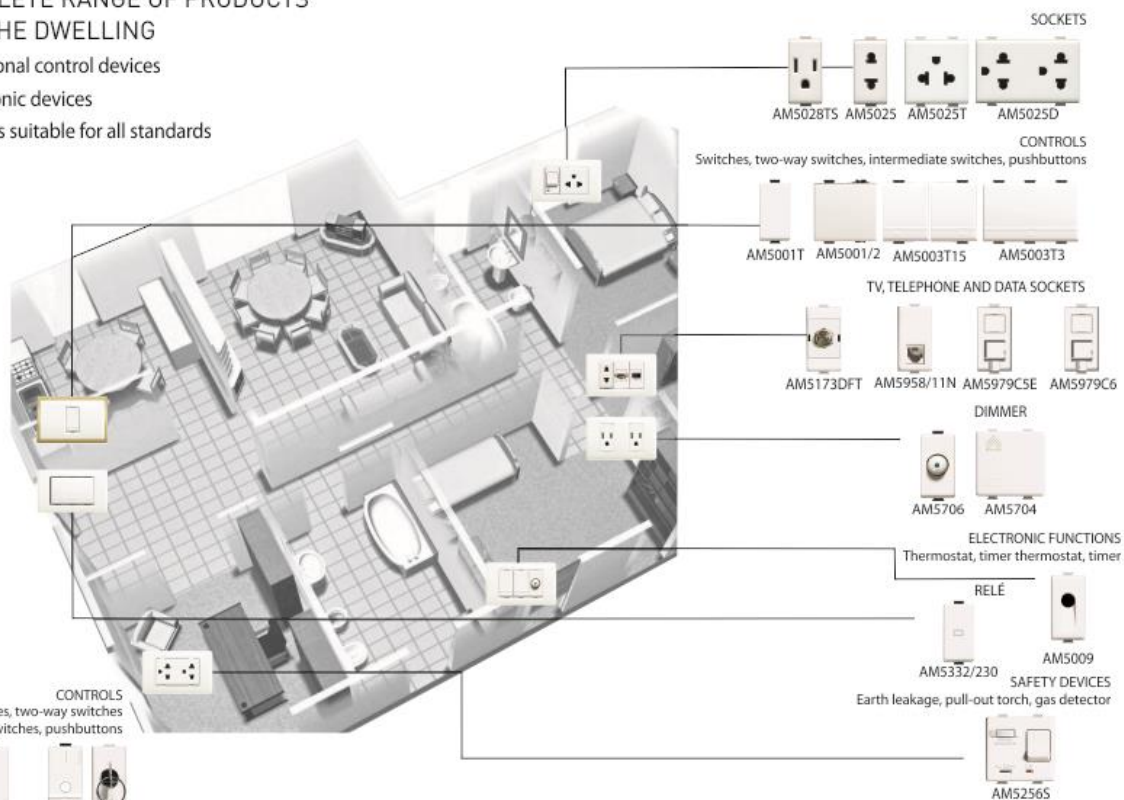

COMPLETE RANGE OF DEVICES FOR THE OFFICE

- traditional and electronic control devices
- sockets suitable for all standards
- RJ connectors
- safety devices and emergency lamps

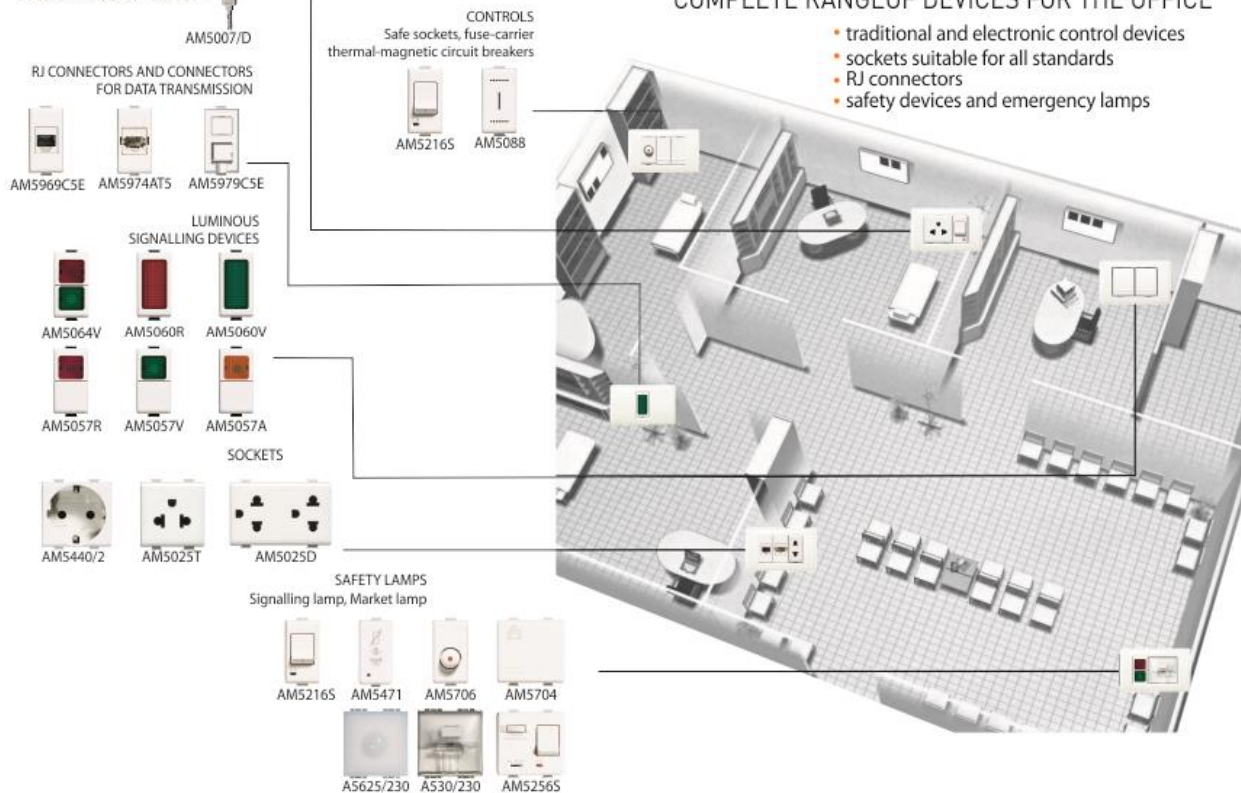

MÀTIX

BASIC CONTROL DEVICES



Item		SWITCHES	Price
AM5001T		1 Way Switch - 1P (16AX)	50.00
AM5001T15		1 Way Switch - 1P (16AX) 1.5 module set of two	220.00
AM5001T3		1 Way Switch - 1P (16AX) 3 module	145.00
AM5003T		2 Way Switch - 1P (16AX)	112.00
AM5003T15		2 Way Switch, 1.5 Mod., - 1P (16AX) set of two	249.00
AM5003T3		2 Way Switch, 3 Mod. - 1P (16AX)	147.00
AM5005T		Pushbutton Switch 1P (NO) with Bell Symbol	210.00
SWITCHES Screwless Terminal			
AM5001WT		1 Way Switch - 1P (16AX)	65.00
AM5003WT		2 Way Switch - 1P (16AX)	129.00
AM5003WT15		2 Way Switch, 1.5 Mod., - 1P (16AX) set of two	261.45
AM5003WT3		2 Way Switch, 3 Mod. - 1P (16AX)	154.45
AM5005WT		Pushbutton Switch 1P (NO) with Bell Symbol	220.50

SOCKET OUTLET

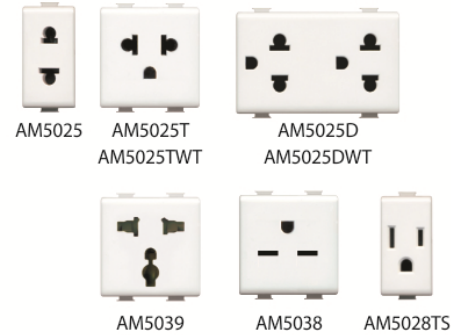

Item		SOCKETS	Price
AM5025		Socket 2P - 1 module - Euro-US standard	72.00
AM5025T		Universal socket 2 module - 2P + G Euro-US standard with safety shutter	160.00
AM5039		Multi-Standard Socket 2P+G 10A 250V	412.00
AM5025D		Duplex Universal Socket - Euro-US standard with safety shutter - 2 P + G	210.00
AM5028TS		Socket 3P - 1 module with ground line	108.00
AM5038		NEMA Tandem 2P + G 15A 250Va.c.	216.00
SOCKETS Screwless Terminal			
AM5025TWT		Universal Socket 2 Mod. 2P + G with Safety Shutter	168.00
AM5025DWT		Duplex Universal Socket 3P, 3 Mod. with Safety Shutter	220.50

Work Excellence
Innovative Solution,
Quality Installation

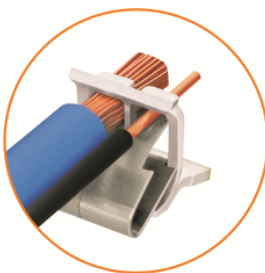

New Automation Terminal Cage Clamps

Innovative automatic terminal for rigid and flexible cables. The constant pressure on the cable guarantees optimal long-lasting contact:

- Simple and quick cabling: you just need to strip the cable and insert it directly into the terminal
- Using a screwdriver for the opening will prevent accidental release in boxes full of cables
- The two independent springs of the terminal guarantee a perfect grip for cables with different diameters, up to 2.5 mm

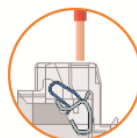

1. Put it directly into the terminal

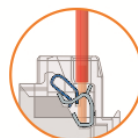

2. Automatic Lock

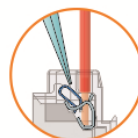

3. Use screwdriver to unlock

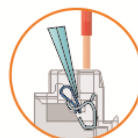

4. Pull out the cable

HOTEL OFFER RANGE



Item	HOTEL OFFER RANGE		Price
AM5765		Key card switch max charge 30VA 230V a.c	3,914.00
L4546		Key-holder card with badge-holder pocket	3,708.00
AM5048		Buzzer 12V a.c. - 5VA - 74db	690.00
AM5041		Bronze bell 230V a.c. - 11VA - 80db	876.00
AM5460		Shaver socket w/ insulation transformer - input voltage 230V a.c. 50/60 Hz - out put 115/230V a.c. 20VA	3,605.00
AM5064VH*		1 module - red and green change over switch 1P	600.00
AM5052		selector switch - rotary change overswitch 1P	690.00
AM5086		- 4 positions to control air conditioner, fans, etc.	1,500.00

USB CHARGERS

USB chargers

Spend less time charging your devices and more time enjoying them! Engineered for compatibility with the latest technology, Leviton USB Charger Devices are designed to charge tablets, smart and mobile phones, gaming devices, e-readers, digital cameras and a host of other electronic devices. The perfect solution for both residential and commercial applications.

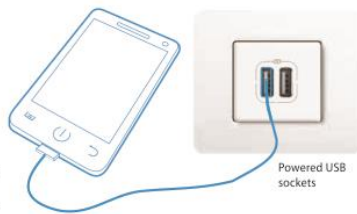

Item	USB CHARGER		Price
AM5285C		USB connector 5 Vd.c. to recharge electronic devices as mobiles, smartphone, tablet and similar, up to 750 mA. Power supply 230 Va.c.	1,170.00
AM5285C2		USB connector 5 Vd.c. to quick recharge of a single electronic devices as mobiles, smartphone, tablet and similar, up to 1550 mA, or simultaneous recharge to two devices up to 750 mA. Power supply 230 Va.c.	1,500.00

OPTICAL AND AUDIBLE SIGNALLING DEVICE



Item	LAMPHOLDER		Price
AM5062B*		1 module - orange and transparent	551.00
AM5064V*		1 module - red and green	441.00
AM5060A*		1 module - orange	505.00
AM5060R*		1 module - red	441.00
AM5060B*		1 module - transparent	441.00
AM5060V*		1 module - green	441.00

*price exclude lamp and should be used with lamp code : LN4742V230

Item	OUTDOOR & INDOOR SIGNALLING LAMP		Price
A5386/230R		red signalling lamp	1,185.00
A5386/230V		green signalling lamp	1,681.00
A5386/230B		white signalling lamp	2,734.00
A5625/230		LED white light - 2 module	1,409.00

caution : The device should be installed over the floor around 160-250 cm. when installation is finished, the device will protrude from the wall 5.2 cm. Use with Lamp code : L4745/230

TELEPHONE, TV AND DATA SOCKET OUTLET



Item	TELEPHONE, TV & COMPUTER SOCKET OUTLET		Price
AM5958/11N		Connector RJ11 cut through- 4 lines	287.00
AM5173D		Shunted coax jack for single user antenna system	542.00
AM5173DFT		Type F TV coax connector- impedance 75Ω- screw coupling	270.00
AM5979C5E		computer RJ45 Cat.5E, toolless type UTP with shutter	500.00
AM5979C6		computer RJ45 Cat.6, toolless type UTP with shutter	600.00

SAFETY DEVICE



Item	FUSE-CARRIER AND FUSE	Price
AM5088	Fuse carrier for 5 x 20 and 6,3 x 32 fuse	536.00
TO/...	-TO 10A - 1 module Fuse 2-15A size ø 6x28 mm.	117.00

fuse carrier can use with fuse TO/15A

Item	SURGE ARRESTER	Price
AM5471	1P surge arrester to be coupled with the user power supply socket – rated discharge current $I_n=1kA$ – maximum current $I_{max}=2ka$ – max protection voltage $U_p=1kV$ – rated voltage $U_n=110-230V$ a.c. – max permanent voltage $U_c=250V$ a.c.	2,472.00

Item	THERMAL-MAGNETIC CIRCUIT BREAKER 230 V A.C	Price
AM5216S	1 module 16A 3kA	1,870.00
AM5256S	2 module earth leakage protection breaker 16A 3kA with one protection 1.n 10mA	3,605.00



AUDIO CONTROL DEVICES MULTI MEDIA SOCKETS



Item	VOLUME CONTROL	Price
AM4269VL	Volume Control 17mm Metal Shaft Rotary Potentiometer with switch	1,200.00

Item	HOTEL FUNCTIONS (MULTI MEDIA SOCKETS)	Price
AM4269HDMIT	Matix HDMI Socket	1,500.00
AM4269HJT	Matix Jack 3.5 Connector	1,100.00
AM4269RWT	Matix Audio RCAx2 Connector	1,000.00
AM4269RWYT	Matix Video RCAx3 Connector	1,300.00
AM4269SVT	Matix S-Video Connector	1,000.00
AM4269USBT	Matix USB Connector	1,000.00
AM4269VGAT	Matix VGA Socket	1,050.00

BOX

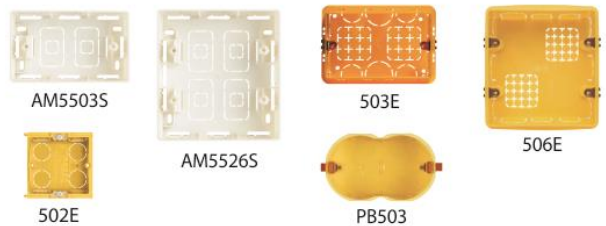

Item	BOX AND SUPPORT	Price
WALL-MOUNTED BOX		
AM5503S	Surface Mounting box for AM55... , Size 115x70x40 mm.	29.00
AM5526S	Surface Mounting box for AM5526, Size 115x122x41 mm.	80.00
FLUSH-MOUNTED		
503E	Yellow - flush mounted box for AM5... , Size 108x74x53.5 mm.	36.00
506E	Yellow - flush mounted box for AM5526, Size 108x118x51.5 mm.	210.00
502E	Yellow - for idrobox 2 module, Size 75x71x53 mm.	231.00
FLUSH-MOUNTED FOR PLASTERBOARD BOX		
PB503	Yellow - Box for plasterboard, Size 124x99x40 mm.	210.00

BASIC CONTROL DEVICE

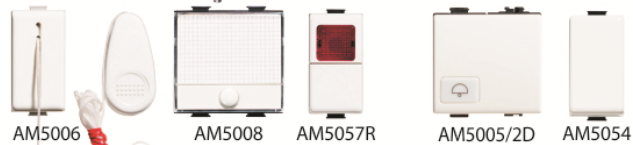

Item	INTERMEDIATE SWITCH – CHANGEOVER SWITCH - KNOB SELECTOR	Price
AM5012T	intermediate switch (16A)	819.00

Item	SWITCH	Price
AM5007D	Key (16A) 250V a.c.	4,429.00
AM5011T	one way switch - 2P (16AX)	350.00

Item	BLANKING MODULE WITH LIGHTABLE SYMBOL	Price
AM5921...	complete the blanking module item code with the symbol reference letter	344.00
AM5921...	as above - 2 modules	375.00
AM5921W	key with white tag	670.00

NOTE: using as a substitute for 1-way switches 1P, 2 way switches 1P, intermediate * able to use with orange light LN4742V230 and green light LN4742V230T (Page 6)

Item	PUSHBUTTON 10A - 250V a.c.	Price
AM5005T	1P (NO) with bell symbol	210.00
AM5005R	1P (NO) with dimmer symbol	221.00
AM5055	Double 1P with (NO) 10A - 250 Vac	626.00
AM5037	Double 1P with arrow (2NO) interlocked	886.00
AM5005/2D	1P (NO) with bell symbol 2 module	361.00
AM5006	1P (NO) with cord-pull	677.00
AM5054	2P (NO) 15A - 250 Vac	399.00
AM5008	2P (NO) Lightable Nameplate with Lamps (1N) 11250L, 11250 LV	32.00
AM5057R	1P(NO)+lamp holder for lamps 1250L-red diffuse	1,375.00
AM5057V	1P(NO)+lamp holder for lamps 11250LV-green diffuse	1,375.00
AM5057A	1P(NO)+lamp holder for lamps 11250L-orange diffuse	1,375.00

Item		GREEN SWITCH AND IR SENSOR
AM5433		Green Switch: switch with movement sensor, through a combination of passive infrared rays and ultrasounds, and brightness sensor. Manual switching on of the light using the front pushbutton, and automatic switching off based on brightness levels and movement. Switch off delay and brightness sensor threshold adjustable using the one/two-way (BMSO4003) remote control, 230 Va.c. power supply.- 2.5 A relay output - 2 modules
AM5434		Green Switch: switch with passive infrared movement sensor - brightness sensor with adjustable threshold and adjustable switch off delay time - manual switching on of the light using the front pushbutton, and automatic switching off based on brightness levels and movement - 2.5 A resistive/inductive relay output - 230 Va.c. power supply - 2 modules
BMSO4003		one-way IR remote control for the selection of the AM5433, AM5434 sensor parameters.

	GREEN SWITCH - FEATURES	
	AM5433	AM5434
		100-240 V-
		50/60 Hz
		2 x 2.5 mm ²
NEUTRAL CONNECTION	YES	NO
		(-5) - (+45) °C
		300 lux
		15 minutes
	2000 W - 230 V- - 8.5 A	40-400 W 0.2-1.7 A 230 V-
	1000 VA - 230 V- - 4.3 A	40-400 VA 0.2-1.7 A 230 V-
	10x (2x36 W) - 230 V- - 4.3 A	
	500 VA - 230 V- - 2.1 A	
	1000 VA - 230 V- - 4.3 A	
	500 VA - 230 V- - 2.1 A	

DIMMER AND PASSIVE INFRARED SWITCH



Item	DIMMER	Price
AM5350	Rotary dimmer 230V a.c. Min:100W Max:300W for incandescent and halogen.	1,607.00
AM5706	Rotary dimmer 1 module for incandescent 100-500 W	1,741.00
AM5704	Touch dimmer 50-500W 127 V a.c. / 50 -1000W 230 V a.c.	2,616.00
AM5707	Touch dimmer 2 module -MOS-FET tech. Soft start and Soft stop - anti-dazzling function built in fuse	3,708.00
AM5709	resistive, inductive, capacitive multiloads touch dimmer 200/400 with electronic protection- 2 modules	3,500.00
AM5710	touch dimmer output 0 - 10 V with electronic protection - 2 modules	6,000.00
AM5713	universal dimmer (resistive – inductive, capacitive, fluorescent compact and dimmer LEDs) - 150/200/400 W with electronic protection - 2 modules	5,000.00

* use with wall box code 503E or PB503 only

Item	PASSIVE INFRARED MOVEMENT DETECTOR SWITCH	Price
AM5751	1 module Automatic on/off 30 sec. to 10 min.	4,697.00
AM5752	2 module Automatic on/off 30 sec. to 10 min. can also be activated by external push button	4,738.00



ON/OFF key (the dimmer saves the brightness level active when the device is switched off, re-proposing it when it is switched back on)

brightness adjustment key

UNIVERSAL DIMMER

With the new BTicino universal dimmers it is possible to control and adjust the light intensity of all types of loads on the market, from traditional filament lamps, to the latest generation LED and CFL energy saving lamps that as required by the regulations, will soon replace them.

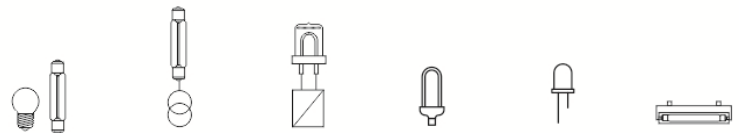

loads managed

Item	Type	range (Va.c.)	Supply std	Incandescents and halogens	Halogens with ferromagnetic transformer	Halogens with electronic transformer	dimmerable compact fluorescents	dimmerable IEd lamps	fluorescents with 0÷10 V ballast
AM5706	Resistive	230 50 ÷ 60	230 Va.c.	100 ÷ 500 W					
AM5704	Resistive Inductive	100 ÷ 230 50 ÷ 60	230 Va.c. 127 Va.c.	50 ÷ 450 W 50 ÷ 800 W	50 ÷ 300 W 50 ÷ 500 W				
AM5709	Multiloads	100 ÷ 240 50 ÷ 60	240 Va.c. 100 Va.c.	20 ÷ 200 W 20 ÷ 400 W	20 ÷ 200 VA 20 ÷ 400 VA	20 ÷ 200 VA 20 ÷ 400 VA			
AM5710	0 - 10 V	100 ÷ 240 50 ÷ 60	240 Va.c. 100 Va.c.						20 ÷ 300 VA 40 ÷ 600 VA
AM5713	Universal	100 ÷ 240 50 ÷ 60	240 Va.c. 100 Va.c.	3 ÷ 200 W 3 ÷ 400 W	3 ÷ 200 VA 3 ÷ 400 VA	3 ÷ 200 VA 3 ÷ 400 VA	3 ÷ 75 W 3 ÷ 150 W	3 ÷ 75 W 3 ÷ 150 W	

COVER PLATES AND ACCESSORY COMPLETE SET (DIY)



Item	BLANK INSERT	Price
AM5000	Blanking plates key	36.00
AM5009	Simple output	116.00
AM5000P/2	Blanking plates	68.00

Item	PLASTIC COVER PLATES	Price
AM5501	Cover plate for 1 module	38.00
AM5502	Cover plate for 2 module	38.00
AM5503	Cover plate for 3 module	38.00
AM5522	Square cover plate	42.00
AM5526	Cover plate for 6 module	152.00
AM5500	Blank cover plate	38.00

Item	DO-IT-YOURSELF (COMPLETE SET)	Price
SAM5001A	One Gang One Way Single Pole Switch 16A 250V	95.00
SAM5001U2A	Two Gang One Way Single Pole Switch 16A 250V	145.00
SAM5001U3A	Three Gang One Way Single Pole Switch 16A 250V	195.00
SAM5003M15A	1.5 Modules 3-way Single Pole Switch 16A 250V	294.00
SAM5003M3A	Three Modules 3-way Single Pole Switch 16A 250V	192.00
SAM5025DA	Duplex Universal Outlet 2P+E 10/16A 250V with safety shutter	255.00
SAM5025SA	One Gang Universal Outlet 2P 16A 250V with safety shutter	117.00
SAM5025TA	Universal/Tandem Outlet 2P+E 10/16A 250V with safety shutter	209.00
SAM5173DFA	One Gang TV Screw Type Connection Socket (F Type)	315.00
SAM5958R11NA	One Gang RJ11 2-Pair Telephone Modular Connection	332.00
SAM5979C5EA	One Gang RJ145 4-Pair Connector Category 5e	545.00
SAM5979C6A	One Gang RJ45 4-Pair Connector Category 6	645.00
SAM5025SU2A	Two Gang Universal outlet 2P 16A	189.00

IDROBOX

WEATHERPROOF COVER AND BOX



PLASTIC WALL MOUNTED HOUSING IP44		
Item		Price
25401	1-Gang Housing (plastic wall-mounted housing)	659.00
25402	2-Gang Housing (plastic wall-mounted housing)	659.00
25403	3-Gang Housing (plastic wall-mounted housing)	691.00
25404	4-Gang Housing (plastic wall-mounted housing)	1,049.00
25404/2	2 x 2-Gang Housing (horizontal layout)	1,050.00
25404/2V	2 x 2-Gang Housing (vertical layout)	1,163.00
25406	6-Gang Housing (plastic wall-mounted housing)	1,453.00
25406V	3 x 2-Gang Housing (vertical layout)	1,580.00
25408	8-Gang Housing (plastic wall-mounted housing)	1,743.00
25406V	2 x 4-Gang Housing (vertical layout)	1,869.00

PLASTIC SURFACE-MOUNTED HOUSING IP55		
Item		Price
25501	Grey color - 1 module Horizontal	747.00
25502	Grey color - 2 module Horizontal	747.00
25503	Grey color - 3 module Horizontal	784.00
25504	Grey color - 4 module Horizontal	1,188.00
25508V	Grey color - 8 module Vertical	1,971.00
25512V	Grey color - 12 module Vertical	2,689.00

ADAPTORS FOR MAGIC		
Item		Price
25703/1	Idrobox adaptor for Magic 1 Module	33.00
25703/2	Idrobox adaptor for Magic 2 Module	135.00
25703/3	Idrobox adaptor for Magic 3 Module	180.00

PLASTIC FLUSH-MOUNTED COVER WITH PARTITIONS - IP55		
Item		Price
25602	2 Gang Cover - Grey	691.00
25603	3 Gang Cover - Grey	490.00



IDROBOX

- The protection degree IP55 is assured by a water-proof gasket and a special system of click closure.
- Useful in particular environments: humid, wet, exposed to bad weather or water jets.
- Can be used for the electric system versions in areas with class 3 explosion danger as both the base and the front door are made of auto-extinguishing resin with elevated resistance features to high temperatures and to fire.



POP - UP

POP-UP AND ACCESSORY



Item	POP-UP FLOOR SOCKET FOR MATIX AND MAGIC ADVANCE SERIES	Price
150628A	Aluminium Pop-up with Euro US socket with ground	2,617.00
150627A	Empty aluminium Pop-up box	2,100.00
150627G	Empty Brass Pop-up box	3,615.00

Item	ADAPTOR FOR WIRING DEVICES & BOX	Price
150625	Adaptor use with 150627A or 150627G	147.00
150626	Adaptor for Light & Living Devices for 150627A & 150627G	147.00
150620P	Plastic floor box 100x100x60 mm.	142.00



Sleek design
extra-slim format to blend discreetly into the office furniture or floor



Item	POP-UP FLOOR SOCKET (3MODULE)	Price
150627NA	Pop Up Square 3 module Aluminium	2,100.00
150627NB	Pop Up Square 3 module Black	2,700.00
150627NS	Pop Up Square 3 module Stainless	2,700.00
150627NG	Pop Up Square 3 module Brass	3,100.00
150628NA	Pop Up Aluminum with Duplex Universal outlet	2,400.00

Item	POP-UP FLOOR SOCKET (4 MODULE)	Price
150647NA	Pop Up Square 4 module Aluminium	2,200.00
150647NB	Pop Up Square 4 module Black	2,800.00
150647NS	Pop Up Square 4 module Stainless	2,800.00
150647NG	Pop Up Square 4 module Brass	3,200.00

Item	POP-UP INSTALLATION KIT & BOX	Price
150620NK	Pop Up Installation Kit 3module	350.00
150640NK	Pop Up Installation Kit 4module	350.00
150620NL	Metal Flush Box F/Concrete 3module	180.00
150640NL	Metal Flush Box F/Concrete 4module	180.00

Item	ADAPTOR FOR WIRING DEVICES	Price
150625N	3M Adaptor for Matix	60.00
150646N	4M Adaptor for Matix	60.00
150626N	3M Adaptor for L&L	75.00
150645N	4M Adaptor for L&L	75.00



Safety and ease of use
soft opening cover with damper and push e slide locking system

PASS & SEYMOUR TWISTLOCK, RECEPTACLES & PLUGS



POWER OUTLETS



Item	TWISTLOCK	Price
L620R	Single receptacle 2P 3 wire, single phase 20A 250V 2P+G	600.00
L630R	Single receptacle 2P 3 wire, single phase 30A 250V 2P+G	639.00
L1520R	Single receptacle 3P 4 wire, 3 phase 20A 250V 3P+G	630.00
L1530R	Single receptacle 3P 4 wire, 3 phase 30A 250V 3P+G	650.00
L1620R	Single receptacle 3P 4 wire, 3 phase 20A 480V 3P+G	740.00
L1630R	Single receptacle 3P 4 wire, 3 phase 30A 480V 3P+G	780.00

Item	POWER OUTLETS (FOR RANGE AND AIRCON OUTLETS)	Price
3801	Power outlet 2P, 3 wire 30A 250V 2P+G	693.00
3804	Power outlet 2P, 3 wire 30A 250V 2P+G	727.00
3890	Power outlet 3P, 3 wire 50A 125/250V	727.00
5851W	Single tandem type receptacle 2P 3 wire 20A 250V	320.00

Item	PLUG	Price
3861	Plug 2P 3 wire for 3801 and 3890 30/50A 125/250V 3P	1,436.00
3869	Plug 2P 3 wire for 3801 and 3804 30/50A 250V 2P+G	1,199.00

Item	PLUGS	Price
L620P	Plug IP20 suitability 2P 3 wire 20A 250V 2P+G	732.00
L630P	Plug IP20 suitability 2P 3 wire 30A 250V 2P+G	860.00
L1520P	Plug IP20 suitability 3P 4 wire 20A 250V 3P+G	826.00
L1530P	Plug IP20 suitability 3P 4 wire 30A 250V 3P+G	937.00
L1620P	Plug IP20 suitability 3P 4 wire 20A 480V 3P+G	998.00
L1630P	Plug IP20 suitability 3P 4 wire 30A 480V 3P+G	1,050.00

Item	COVER PLATES	Price
SS724	Stainless cover plates for power outlets	151.00
TP724W	White cover plates for power outlets	197.00
SS7	Stainless cover plates for 5851-W	151.00
TP7W	White cover plates for 5851-W	111.00

Item	COVER PLATES	Price
SS720	Stainless cover plates for twistlock	151.00
TP720W	White cover plates for twistlock	202.00

INDUSTRIAL EQUIPMENT POWER PLUG



STRAIGHT PLUGS



MOBILE SOCKETS



SURFACE MOUNTING SOCKETS



PANEL SOCKETS

Item	P17 TEMPRA IP44 STRAIGHT PLUGS	Price
057434	16A 230V 2P+E 50/60Hz	750.00
058134	32A 230V 2P+E 50/60Hz	1,130.00
057438	16A 400V 3P+E 50/60Hz	520.00
057439	16A 400V 3P+N+E 50/60Hz	650.00
058138	32A 400V 3P+E 50/60Hz	897.00
058139	32A 400V 3P+N+E 50/60Hz	1,137.00

Item	P17 TEMPRA IP44 MOBILE SOCKETS	Price
057514	16A 230V 2P+E 50/60Hz	815.00
058214	32A 230V 2P+E 50/60Hz	1,720.00
057518	16A 400V 3P+E 50/60Hz	742.00
057519	16A 400V 3P+N+E 50/60Hz	905.00
058218	32A 400V 3P+E 50/60Hz	975.00
058219	32A 400V 3P+N+E 50/60Hz	1,230.00

Item	P17 TEMPRA IP44 PANEL SOCKETS	Price
057364	16A 230V 2P+E 50/60Hz	855.00
057612	32A 230V 2P+E 50/60Hz	2,560.00
057368	16A 400V 3P+E 50/60Hz	1,120.00
057369	16A 400V 3P+N+E 50/60Hz	1,400.00
057618	32A 400V 3P+E 50/60Hz	1,650.00
057624	32A 400V 3P+N+E 50/60Hz	2,000.00

Item	P17 TEMPRA IP44 SURFACE MOUNTING SOCKETS	Price
055553	16A 230V 2P+E 50/60Hz	1,120.00
055573	32A 230V 2P+E 50/60Hz	1,500.00
055557	16A 400V 3P+E 50/60Hz	1,200.00
055558	16A 400V 3P+N+E 50/60Hz	1,300.00
055577	32A 400V 3P+E 50/60Hz	1,300.00
055578	32A 400V 3P+N+E 50/60Hz	1,820.00

INDUSTRIAL EQUIPMENT

- The design and strength of the materials used in p17 Temptra plugs and sockets make them suitable for use in most environments. They have been designed and developed to ensure that connections on industrial and commercial sites are durable and safe



RAPID CHOICE AND QUICK INSTALLATION

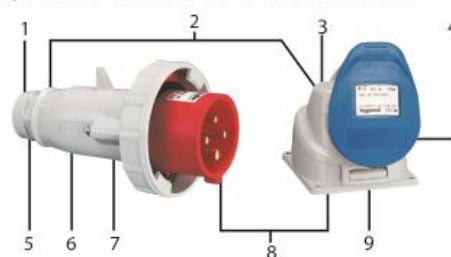

1. Pre cut membrane cable gland
2. Label spaces
3. Shake-proof rapid fixing screws
4. Removable internal connection Block
5. Rapid fix external cable clamp screws
6. Grip zone
7. Shake-proof rapid fixing screws
8. Connection terminals with rapid screws
9. Screwless fast closing of the socket cover

- cable clamp grip inserted in the cable gland : fix the cable securely without dismantling the plug, thus providing excellent shock resistant. Wire stripping guide engraved on the pins and sleeves supports

INDUSTRIAL EQUIPMENT POWER PLUG



STRAIGHT PLUGS



PANEL SOCKETS



SURFACE MOUNTING SOCKETS



MOBILE SOCKETS

Item	P17 TEMPRA IP66 STRAIGHT PLUGS	Price
056303	16A 230V 2P+E 50/60Hz	1,890.00
056823	32A 230V 2P+E 50/60Hz	2,600.00
058700	63A 230V 2P+E 50/60Hz	3,768.00
056307	16A 400V 3P+E 50/60Hz	2,180.00
056308	16A 400V 3P+N+E 50/60Hz	2,297.00
056327	32A 400V 3P+E 50/60Hz	2,620.00
056328	32A 400V 3P+N+E 50/60Hz	2,900.00
058704	63A 400V 3P+E 50/60Hz	3,910.00
058705	63A 400V 3P+N+E 50/60Hz	4,200.00
059126	125A 400V 3P+E 50/60Hz	15,178.00
059127	125A 400V 3P+N+E 50/60Hz	11,500.00

Item	P17 TEMPRA IP66 MOBILE SOCKETS	Price
056203	16A 230V 2P+E 50/60Hz	2,234.00
056223	32A 230V 2P+E 50/60Hz	3,500.00
058710	63A 230V 2P+E 50/60Hz	4,900.00
056207	16A 400V 3P+E 50/60Hz	2,624.00
056208	16A 400V 3P+N+E 50/60Hz	3,020.00
056227	32A 400V 3P+E 50/60Hz	3,450.00
056228	32A 400V 3P+N+E 50/60Hz	3,750.00
058714	400V 3P+E 50/60Hz	6,332.00
058715	400V 3P+N+E 50/60Hz	5,500.00
059136	400V 3P+E 50/60Hz	19,788.00
059137	400V 3P+N+E 50/60Hz	14,980.00

Item	P17 TEMPRA IP66 PANEL SOCKET	Price
057651	16A 230V 2P+E 50/60Hz	2,017.00
057652	32A 230V 2P+E 50/60Hz	2,650.00
058720	63A 230V 2P+E 50/60Hz	3,540.00
057657	16A 400V 3P+E 50/60Hz	2,310.00

Item	P17 TEMPRA IP66 PANEL SOCKET	Price
057663	116A 400V 3P+N+E 50/60Hz	2,335.00
057658	32A 400V 3P+E 50/60Hz	2,500.00
057664	32A 400V 3P+N+E 50/60Hz	2,700.00
058724	63A 400V 3P+E 50/60Hz	4,050.00
057369	63A 400V 3P+N+E 50/60Hz	1,400.00
059116	125A 400V 3P+E 50/60Hz	13,800.00
059117	125A 400V 3P+N+E 50/60Hz	10,900.00

Item	P17 TEMPRA IP66 SURFACE MOUNTING SOCKETS	Price
055303	16A 230V 2P+E 50/60Hz	2,400.00
055323	32A 230V 2P+E 50/60Hz	3,325.00
058740	63A 230V 2P+E 50/60Hz	4,760.00
055307	16A 400V 3P+E 50/60Hz	2,653.00
055308	16A 400V 3P+N+E 50/60Hz	2,847.00
055327	32A 400V 3P+E 50/60Hz	3,120.00
055328	32A 400V 3P+N+E 50/60Hz	3,560.00
058744	63A 400V 3P+E 50/60Hz	4,970.00
058745	63A 400V 3P+N+E 50/60Hz	5,850.00
059106	125A 400V 3P+E 50/60Hz	28,320.00
059107	125A 400V 3P+N+E 50/60Hz	31,200.00



649914



060405



060415



060451

Item	TIMER SWITCH & BULKHEAD LIGHT	Price
649914	Analogue time switch, 24 Hour daily programme - 20A 50/60Hz 250 V~	2,500.00
060405	Bulkhead light IP 44 - IK 06 - oval 60 W - E27 - plastic grid screwfixing -grey	490.00
060415	Bulkhead light - IP 44 - IK 06 - oval 60 W - E27 - metal grid screw fixing -grey	500.00
060451	Bulkhead light - IP 44 - IK 07 - round - E 27 - glass diffuser	515.00

COVERING RANGE

Covering range for item BMSA1101

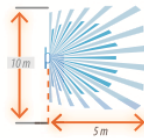
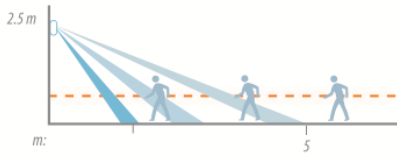

H (m)	W (m)	D (m)	Maximum	
			D (m)	S (m ²)
2.5	10	5	39	
3	10	5	39	
4	12	6	57	
5	14	7	77	
6	16	8	100	

Legend:
H = Installation height (m)
W = Width (m)
D = Depth (m)
S = Surface (m²)

Covering range for item BMSA2102

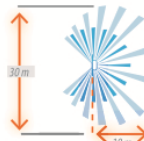
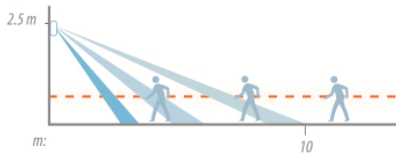

Customisable sensitivity level

H (m)	W (m)	D (m)	S (m ²)	Low			Medium			High			Maximum		
				W (m)	D (m)	S (m ²)	W (m)	D (m)	S (m ²)	W (m)	D (m)	S (m ²)	W (m)	D (m)	S (m ²)
2.5	8	3	66	15	5	131	23	8	197	30	10	263			
3	8	3	66	15	5	131	23	8	197	30	10	263			
4	8	2	58	15	5	116	23	7	174	30	9	233			
5	8	2	53	15	4	105	23	6	158	30	8	210			
6	8	2	47	15	4	94	23	5	141	30	7	188			

Legend:
H = Installation height (m)
W = Width (m)
D = Depth (m)
S = Surface (m²)

Covering range for item BMSA2202

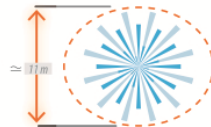
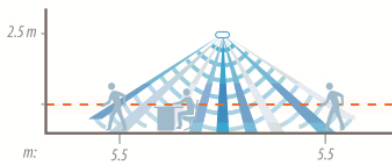

Customisable sensitivity level

H (m)	Sensor technology	Low		Medium		High		Maximum	
		∅ (m)	S (m ²)	∅ (m)	S (m ²)	∅ (m)	S (m ²)	∅ (m)	S (m ²)
2.5	PIR	4	15	6	25	6.5	30	8	50
	US	4	15	4	15	6	30	11	95
3	PIR	5.5	25	6.5	35	8.5	60	11.5	100
	US	6	30	6	30	8	50	13	150
4	PIR	6.5	35	7.5	45	12.5	125	14	155
	US	6	30	6	30	10	80	13	150
5	PIR	6	30	10.5	90	12	115	16.5	215
	US	6	30	6	30	10	80	13	130
6	PIR	4	15	5.5	25	8.5	60	12.5	125
	US	-	-	6	30	10	80	13	130

Legend:
H = Installation height (m)
∅ = Diameter (m)
S = Surface (m²)

BOXES

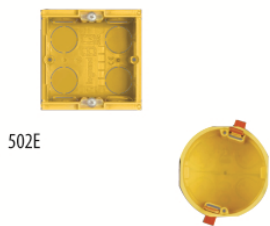

Item	Description	Price
502E	2 module masonry ceiling flush mounted box for the installation of Switch Sensors items BMSA2201, BMSA2202 dimensions 71 x 71 x 53.5 mm	75
PB502	2 module plaster coated and double board ceiling flush mounted box for the installation of Switch Sensors items BMSA2201, BMSA2202, dimensions ∅ 68 x 51 mm	151

D45 SYSTEM

HIGH PERFORMANCE DOOR ENTRY SYSTEM

The BTicino D45 DOOR ENTRY SYSTEM consists of five main components: entrance panels, indoor audio and video handsets, porter handsets, porter switchboard, accessories and power supply. It is a security monitoring system using serial devices connected using DIGITAL BUS technologies. The system is designed to perform such functions as call, doorbell, conversation, monitor, unlock, network and alarms,

by connecting riser systems to system network devices. The porter switchboard is used as the management and control centre for the entire system. With the smart power supply for the whole system, devices detect the power load status automatically so that they can switch to power saving mode if necessary. Approximately 70% less copper is used, thus reducing the environmental impact.



7 inch Hands-free colour handset



Audio Handset



Table-Top Porter Switchboard

D45 SYSTEM

High performance
for multi-storey
and large buildings

INSTALLATION OF UP TO:

- 4000** Apartments
- 800** Handsets per riser
- 80** Entrance panels per riser
- 16** Porter switchboards
- 100** Riser shunts
- 1 km** Distance for colour video installation
- 2 km** Distance for B/W video installation



Simplicity

The use of UTP cables and RJ45 connectors is easy and economical compared to traditional cable installations. In large applications it makes a significant difference to the total price.

D45 SYSTEM

Innovative security functions

In addition to the standard functions of door entry systems, the D45 SYSTEM provides new, innovative security functions:

- *Sos pushbutton on all indoor handsets*
- *Intercom between all riser apartments*
- *Anti-tamper function on indoor handsets*
- *Possibility to connect an additional camera to switchboard*

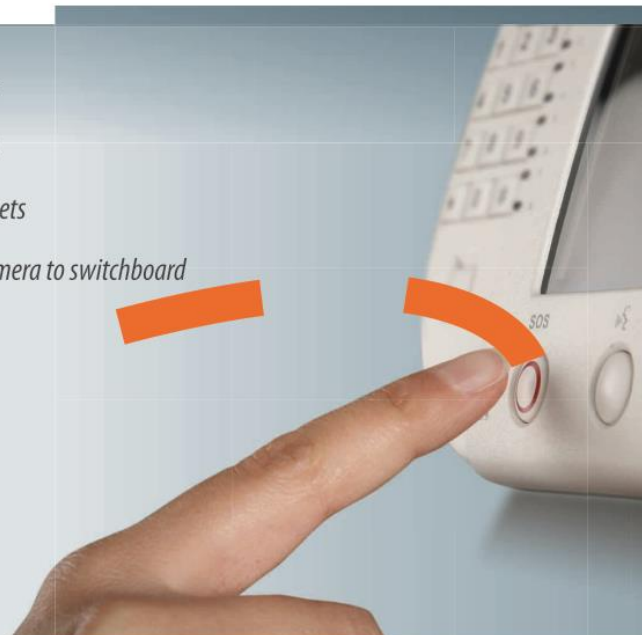

International design

The international design of the devices combined with the technological expertise of the Legrand Group makes them the perfect choice for modern homes:



D45 SYSTEM

Simplifies your building installation

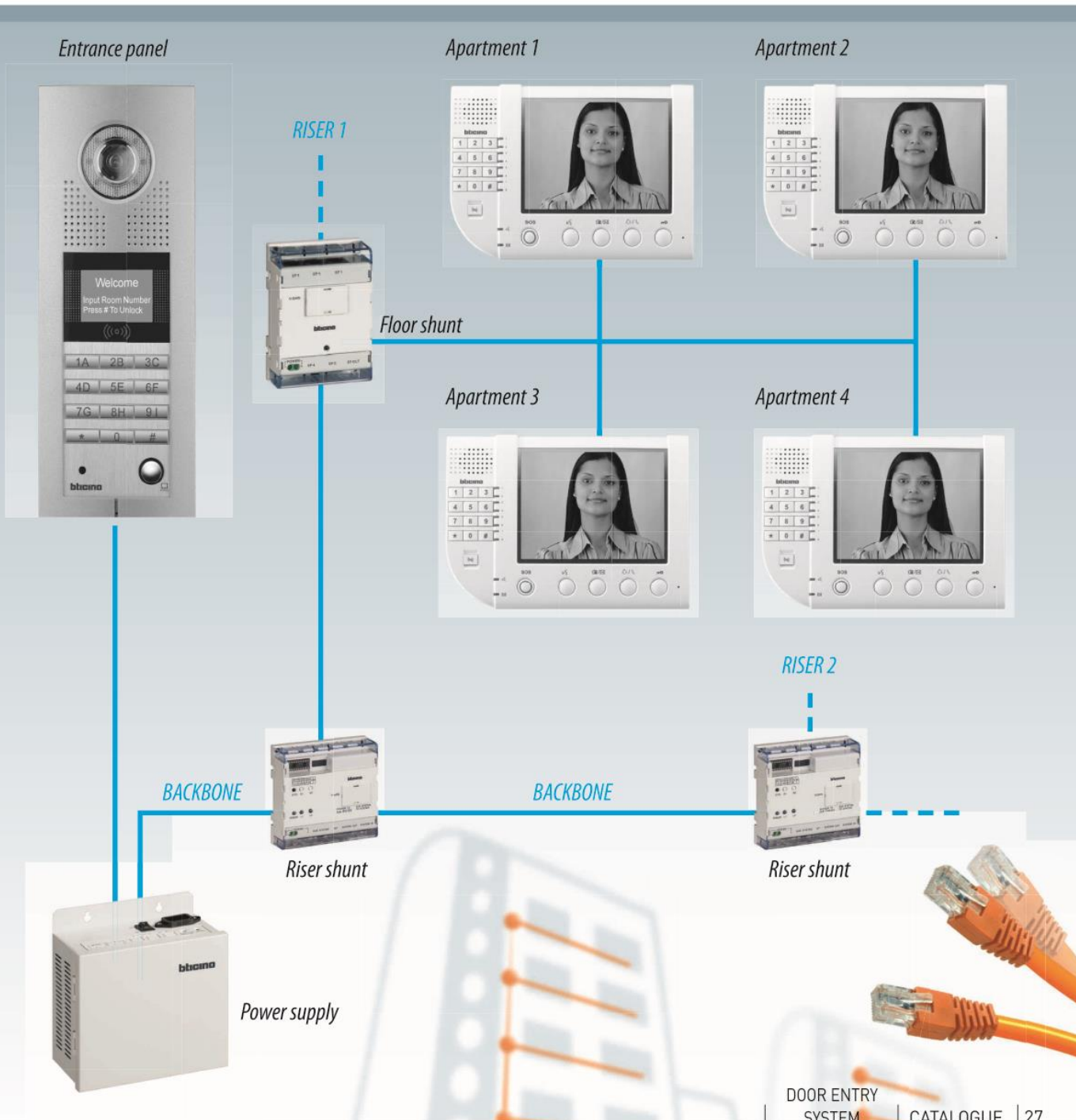

D45

DOOR ENTRY SYSTEM



322010



322020



322040



322050



321010



323002



323003



323005



323009

Item	ENTRANCE PANELS
322010	<p>Digital Colour Entrance Panel</p> <p>Zamak alloy digital entrance panel with key board LCD display and colour camera. Equipped with door open and burglar alarm notification. Configuration screen menu and software upgrade without dismantling the device. Flush-mounting box supplied.</p>
322020	<p>Small Colour Entrance Panel</p> <p>Aluminum alloy small entrance Panel to be installed on the front of the apartment door. Touch-sensitive pushbutton for calling indoor handsets and direct conversation. Double verified intercom calls. Protection Index IP54 Surface-mounting</p>

Item	COLOUR INDOOR HANDSETS
322050	<p>7 inch Hands-free Colour Handset</p> <p>Colour unit with alarm function, equipped with 7 inch TFT LED backlit screen. Functions: standard door entry, door open pushbutton and call to porter switchboard. 12 different ring tones (selectable). Super slim frame for wall mounting.</p>
321010	<p>5.6 inch Hands-free colour Handset</p> <p>Colour unit with alarm function, equipped with 5.6 inch TFT LED backlit screen. Functions: Standard VDE, door open pushbutton and call to porter switchboard. Red SOS pushbutton available. 12 different ring tones (selectable). Wall Mounting</p>

Item	AUDIO INDOOR HANDSETS
322040	<p>Audio Handset</p> <p>Basic audio handset with door open pushbutton. Compact size and low power consumption. Wall-mounting.</p>

Item	PORTER SWITCHBOARD
323001	<p>Table-top porter switchboard</p> <p>Switchboard device with high resolution 7 inch LCD display and icon menu. Able to communicate with handsets, entrance panels and other devices. Manages incoming calls and alarms. Can store thousands of call and alarm records. Provides quick message retrieval using handset addresses. Table-top installation.</p>

For any inquiry on this product and solution, please contact BTicino Sales or send an email to btsales.ph@bticino.com

Item	SYSTEMS ACCESSORIES
323002	<p>Floor Shunt</p> <p>This is used to convert video signals on the BUS to transfer made and then distribute them to the connected handsets. Device to be installed between floors. Each floor shunt can be connected to 4 handsets. DIN rail installation.</p>
323003	<p>Riser Shunt</p> <p>This is used to connect the riser BUS & system BUS in order to obtain BUS separation, transfer signals and switch between video and audio channels. The video transfer distance can be increased by setting the gain adjustment dip switch. DIN rail installation.</p>
323009	<p>Apartment Interface</p> <p>Device used to expand the number of indoor handsets and add a secondary entrance panel. Each device can connect 5 handsets and 1 entrance panel, providing the intercom function and call or monitor function of the entrance panel. DIN rail installation.</p>
323018	<p>EP/Switchboard Shunt</p> <p>DIN device used to connect the entrance panel and the switchboard to the system. The device automatically switches over the video channels. DIN rail installation.</p>
323005	<p>Power Supply</p> <p>System power supply unit able to supply power on the data communication cable and simultaneously provide impedance matching for the audio channel. Protected against short circuits: if there is a DC output short-circuit, the device will switch to protected mode. Once the problem has been resolved, it will return to normal status automatically. Can also be set-up to operate as an auxiliary power supply. Wall mount installation.</p>
323010	<p>Auxiliary Power Supply</p> <p>Auxiliary power supply protected against the short circuits: if there is a DC output short-circuit, the device will switch to protected mode. Once the problem has been resolved, it will return to normal status automatically. Wall mount installation.</p>
323020	<p>Configuration Tool</p> <p>Configuration kit composed by:</p> <ol style="list-style-type: none"> 1. F2 configuration software 2. Tool interface 3. Serial Extension Cable 4. Flat cable
3501k	<p>Configuration Kit</p> <p>Inclusion: 1. 10 of each type of configuration (from 0-9) 2. 2 green removable clamp connectors 3. 1 configuration insertion clamp 4. 1 plastic screw driver</p>

Legrand World Wide



- Establishments in some 80 countries
- Sales in more than 180 countries
- 36,000 Employees
- 20 Global Regional Brands that are leaders on their market

Bticino Philippines, Inc.
G/F All Seasons Bldg., 112 Aguirre St.,
Legaspi Village, Makati City,
Philippines 1229

Tel.: (+632) 892 8972
Fax: (+632) 892 8971
www.bticino.com

The company reserves the right to modify
the content of the present booklet at any time.

bticino
A Group Brand | **legrand**